

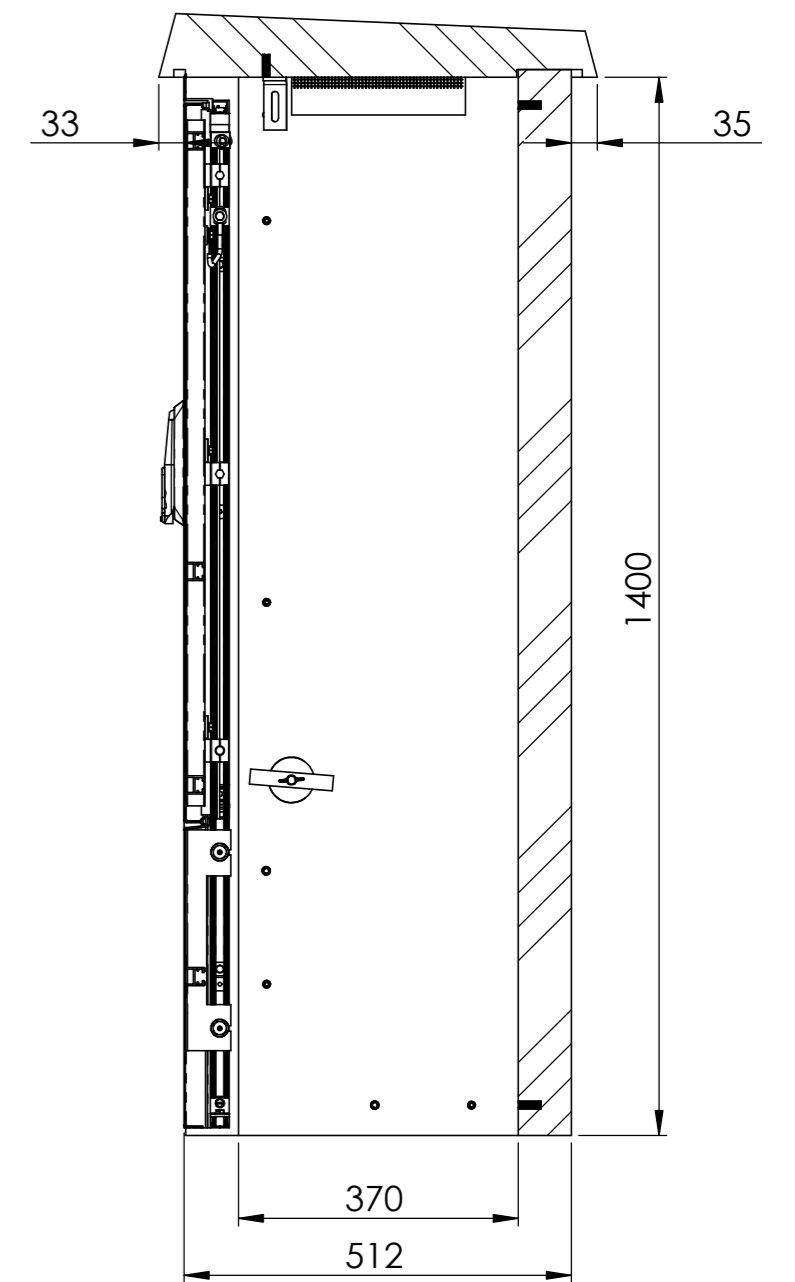

SCHNITT A-A
MABSTAB 1 : 10

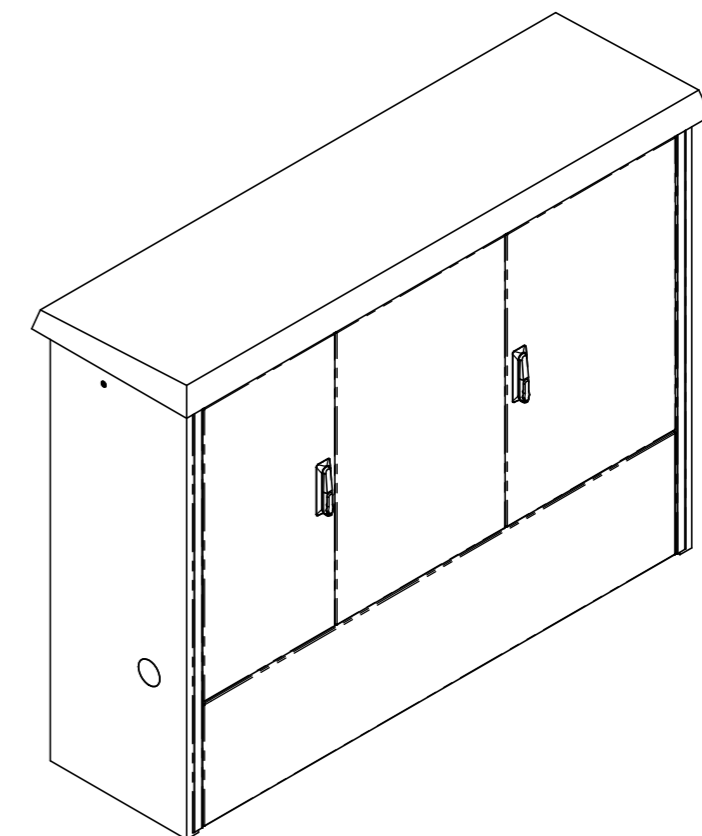

SCHNITT B-B
MABSTAB 1 : 10

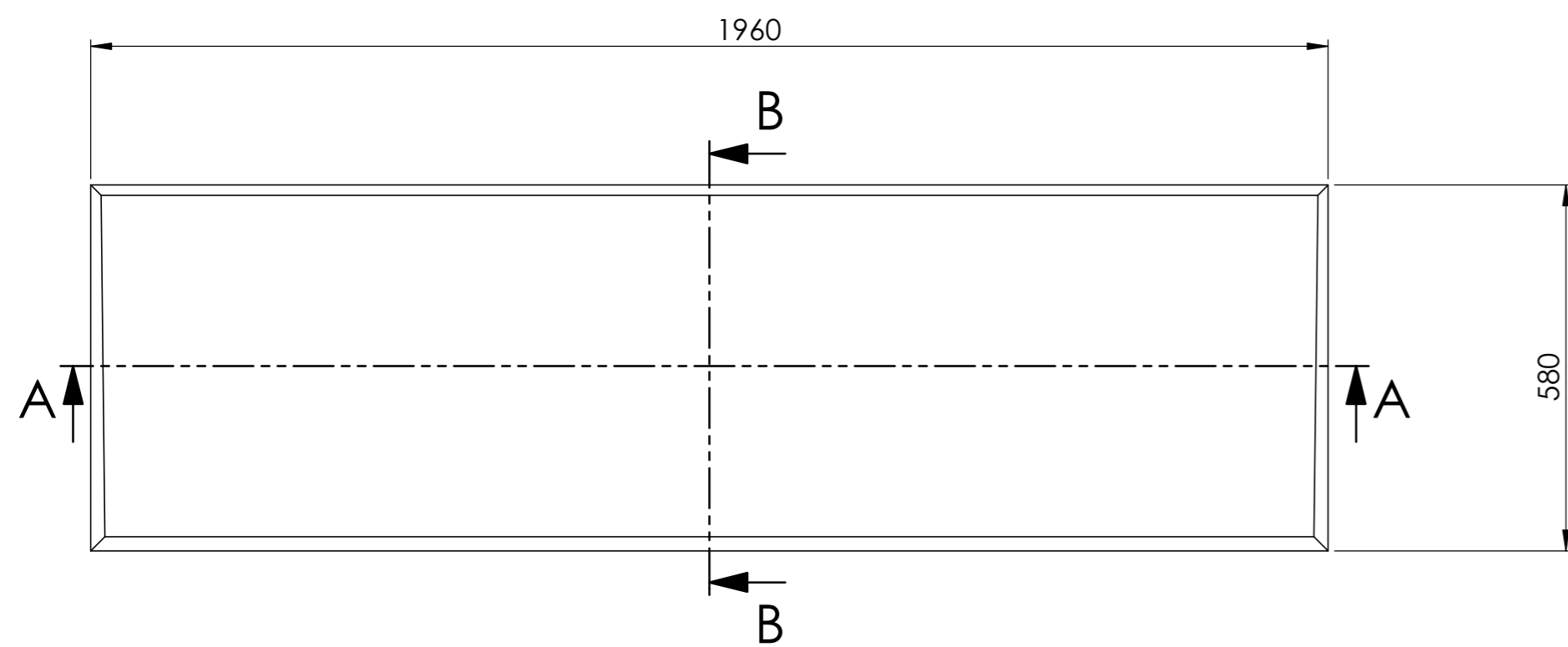

Allgemeintoleranzen ISO 2768-m		Material:		Gewicht: 850 Kg		
Florida 17 TV 5EL			Masstab	Gezeichnet	07.01.2021	MH
			1:5	Geprüft	07.01.2021	MH
			Format	Zeichnungsnr.		
			A2	020-308		